

# ElectroForce® 3200 Series III

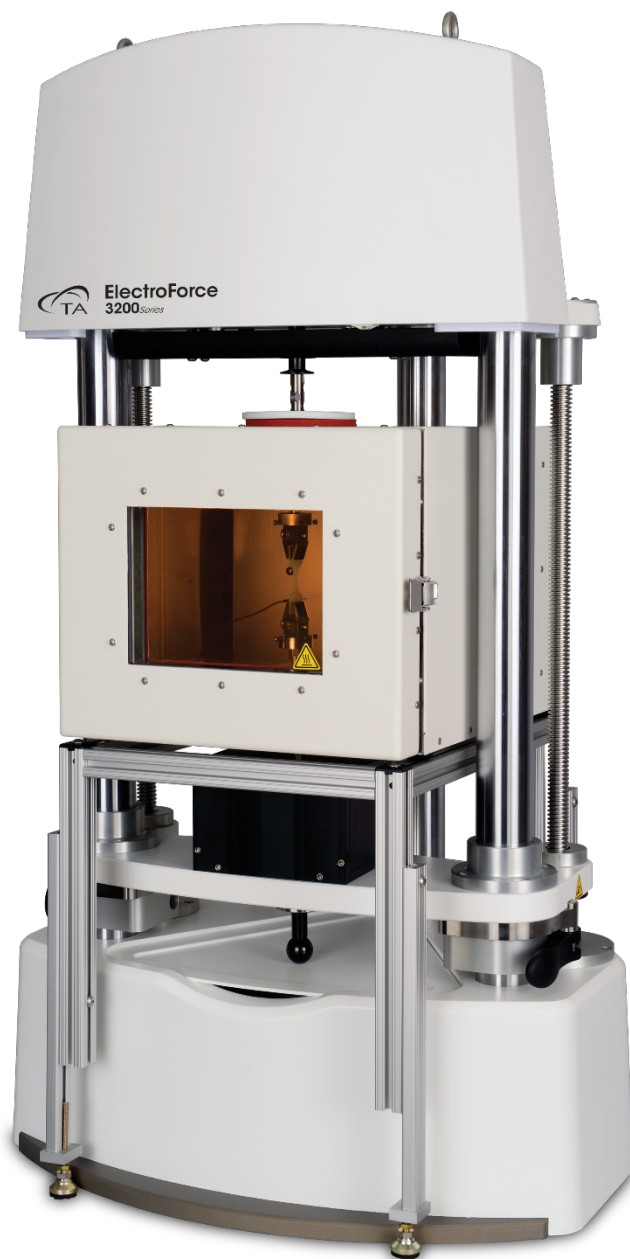

## Site Preparation Guide

# Table of Contents

Table of Contents .....	2
Ideal Setup .....	3
System Components.....	4
Instrument Measurements .....	5
Utility Requirements.....	6–7
Power .....	6
Gas .....	7
Computer Requirements .....	8–9
Hardware .....	8
Software.....	9
Accessories (ACS).....	10–12
Site Preparation Checklist .....	13
TA Instrument Offices.....	14



Circulator



Power



Cooling



Gas



LN<sub>2</sub>



Fluid



Light



Hardware



Software



Temp



Lab



Customer

# Ideal Setup



## IDEAL PLACEMENT AND BENCH MEASUREMENTS

Select a location with adequate floor and ceiling space and a rigid laboratory bench that is level and is in a vibration-free environment. For dynamic mechanical analysis or high-resolution force or displacement data, place the system on a seismic mass of ~80 kg. Bench must be rated to support several hundred pounds plus seismic mass.



Bench width: 1.5 m (5 ft)

Table width: 1.5 m (5 ft)

Bench depth: 1.2 m (4 ft)

Distance from the wall:  
0.15 m (0.5 ft) min.

# System Components



## MAIN SYSTEM COMPONENTS

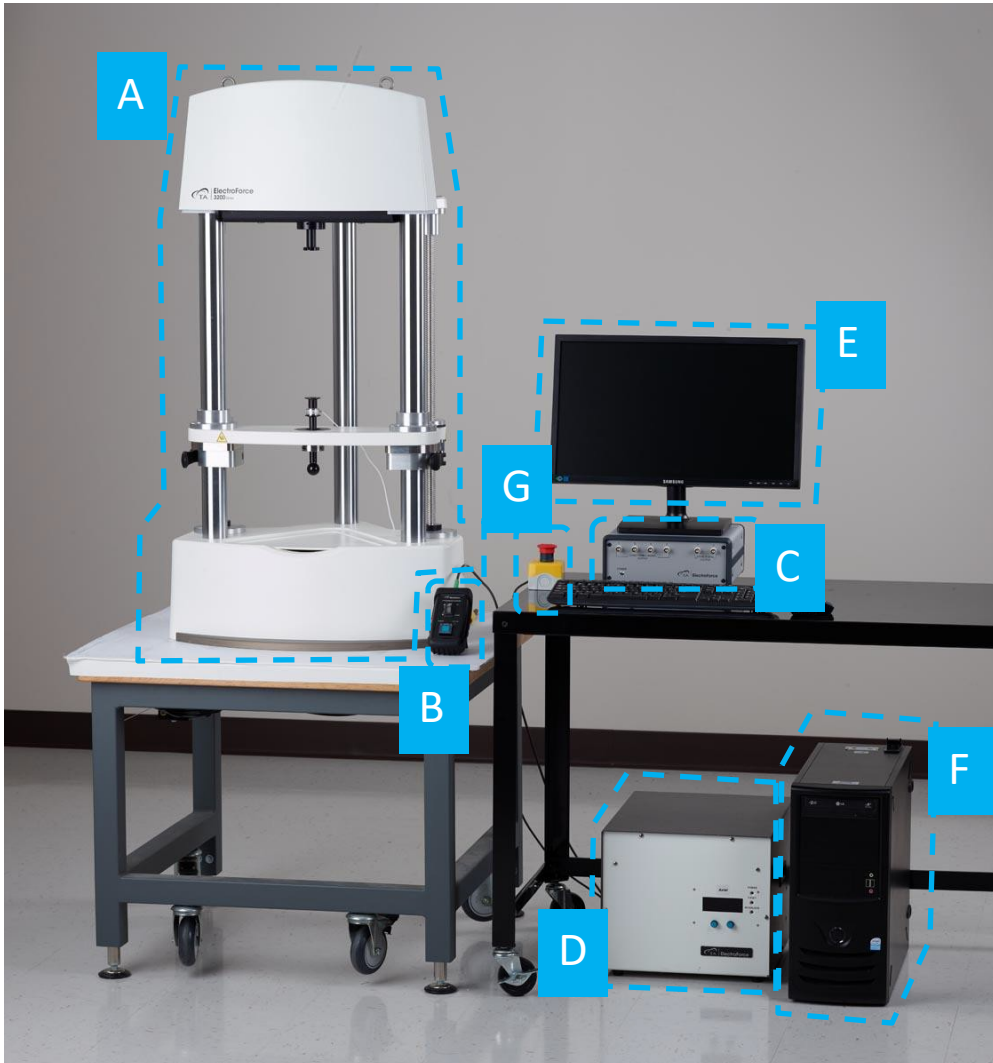

- |                         |                     |
|-------------------------|---------------------|
| A. Test Instrument      | E. Computer Monitor |
| B. Lift Remote          | F. Computer Tower   |
| C. PCI Electronics Box  | G. Emergency Stop   |
| D. Power Supply (Axial) |                     |

# Instrument Measurements



## 3200 SERIES III TEST INSTRUMENT



Height: 1051 mm (41.4 in)

Width: 579 mm (22.8 in)

Depth: 518 mm (20.4 in)

Weight: 98 kg (215 lbs)



Weight with Extended  
Stroke Actuator:  
100 kg (219 lbs)

Weight with Torsion:  
113 kg (250 lbs)

# Utility Requirements



## POWER

Item	Requirement
Instrument Power	<ul style="list-style-type: none"> <li>• 104–132V, 50–60 Hz, 15A</li> <li>• 207–230V, 50–60 Hz, 10A</li> <li>• Neutral to Ground (NG) voltage max 0.5 volt</li> <li>• Safety ground per local regulation</li> </ul>
PCI Box Power	<ul style="list-style-type: none"> <li>• 104–120V 50-60 Hz, 1.2 A</li> <li>• 207–230V 50-60 Hz, 0.6 A</li> </ul>
FCO Power	<ul style="list-style-type: none"> <li>• 180–264V, 50–60 Hz, 13A</li> <li>• Dedicated outlet</li> </ul>
LSO Power	<ul style="list-style-type: none"> <li>• 110 V, 50–60 Hz, 14A</li> <li>• 220 V, 50–60 Hz, 7A</li> <li>• Dedicated outlet</li> </ul>
ACS Power	<ul style="list-style-type: none"> <li>• 216–252V, 60 Hz, 9A</li> </ul> <p> For US nominal 208 V power lines, a buck-boost transformer is recommended, such as the ACME T181059 or equivalent 0.75kVA-rated transformer.</p> <ul style="list-style-type: none"> <li>• 207–252V, 50 Hz, 9A</li> <li>• Dedicated outlet</li> </ul>
Power cords provided	<ul style="list-style-type: none"> <li>• 6-20P plug for 230V systems</li> <li>• 5-15P plug for 120V systems</li> </ul> <div style="display: flex; justify-content: space-around; align-items: center;">  6-20P              5-15P         </div>



**Use power cords with plugs appropriate for your circuit.**



Supply voltages lower than indicated may result in a degradation of performance.



Ensure that the mains assigned do not also supply power to noise generating equipment nearby, such as motors, welders, transformers, etc.



An independent heavy GROUND wire must be provided through the power hookup. Improper grounding may cause severe damage for which the supplier will not accept responsibility. All power strips must be fully grounded and carry the ground through to the sockets into which the computer is plugged.

# Utility Requirements



## GAS

Item	Requirement			
	Air Bearings	FCO	ACS	LSO
Purge gas	Air	Air or nitrogen	Air	Liquid nitrogen
Pressure	413–515 kPa (60–80 psig)	275–689 kPa (40–100 psig)	515–620 kPa (80–90 psig)	151–344 kPa (22–50) psig
Flow	8.5 L/min (0.3 CFM)	145 L/min (5 CFM)	200 L/min (7 CFM)	N/A
Connections	¼-inch NPT female to filter/dryer/ regulator	¼-inch NPT female to filter/regulator	8 mm O.D. tubing (Push to Connect)	½-inch SAE, 45 degree flare fitting
Conditions	<ul style="list-style-type: none"> <li>• Grade 5</li> <li>• Must be free from oil and dirt</li> </ul> Dew point $\leq 10^{\circ}\text{C}$			

# Accessories



## ACS-2 MEASUREMENTS



Height: 88.5 cm (35 in)

Width: 37 cm (14.5 in) WITHOUT Chiller Panel

Width: 52 cm (20.5 in) WITH Chiller Panel

Depth: 56 cm (22 in)

Weight: 96 kg (211 lbs) WITHOUT Chiller Panel

Weight: 112 kg (247 lbs) WITH Chiller Panel



## ACS-3 MEASUREMENTS

Height: 112 cm (44 in)

Width: 37 cm (14.5 in) WITHOUT Chiller Panel

Width: 52 cm (20.5 in) WITH Chiller Panel

Depth: 56 cm (22 in)

Weight: 121 kg (267 lbs) WITHOUT Chiller Panel

Weight: 137 kg (302 lbs) WITH Chiller Panel





# Accessories



## FCO & LSO CHILLER PANEL MEASUREMENTS

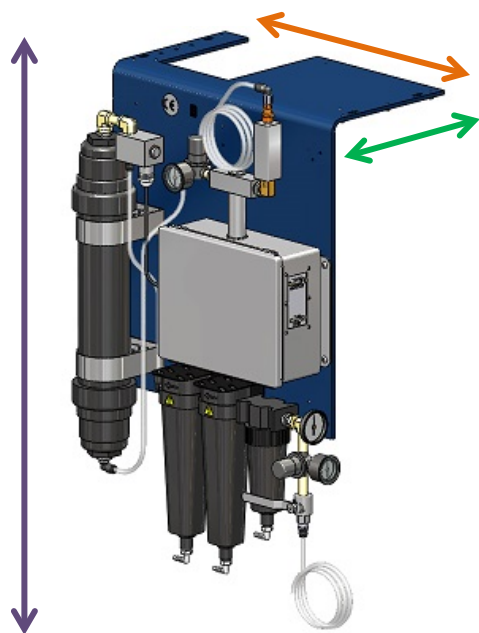

Height: 86.4 cm (34 in)

Width: 48.3 cm (19 in)

Depth: 38.1 cm (15 in)





Weight: 15.8 kg (35 lbs)

# Accessories



## AIR COOLING SYSTEM REQUIREMENTS

### Requirements

	<ul style="list-style-type: none"><li>• 50 Hz: 207–252 VAC (refer to the serial number plate on the rear of the unit. The ACS is line frequency specific.)</li><li>• 60 Hz: 216–252 VAC (refer to the serial number plate on the rear of the unit. The ACS is line frequency specific.)</li><li>• 8A, 9A, 9.1A, or 11A (refer to the serial number plate on the rear of the unit)</li><li>• US sites require an L6-20 single-phase outlet </li></ul>
	<ul style="list-style-type: none"><li>• Gas:<ul style="list-style-type: none"><li>• Air or nitrogen</li><li>• Pressure: 6.2–6.9 bar (90–100 psig)</li><li>• Flow rate: 200 L/min</li><li>• Temperature: 20–30°C</li><li>• Dew point: Must not exceed the ambient air temperature by more than 5°C. Specified at operating pressure.</li></ul></li></ul>  <p>NEMA L6-20 plug</p>
	<ul style="list-style-type: none"><li>• Lab Environment (must be below 25°C):<ul style="list-style-type: none"><li>• 12°C–21°C = Acceptable</li><li>• 21°C–24°C = Ideal</li></ul></li><li>• Leave 20 cm (8 in) of space in the front and back of the ACS for ventilation</li></ul>



Circulator



Power



Cooling



Gas



LN<sub>2</sub>



Fluid



Light



Hardware



Software



Temp



Lab



Customer



# TA Instruments Offices

For information on our latest products, contact information, and more, see our website at:  
<http://www.tainstruments.com>.

To find your local TA Instruments office and contact information, visit  
<http://www.tainstruments.com/contact/ta-directory/>

TA Instruments – Waters LLC  
Corporate Headquarters  
159 Lukens Drive  
New Castle, DE 19720  
USA

Telephone: 302-427-4000  
Fax: 302-427-4001  
Email: [info@tainstruments.com](mailto:info@tainstruments.com)