

•DISCOVERY.  
*series*



TA Instruments

New Castle, DE USA

Lindon, UT USA

Pittsburgh, PA USA

Elstree, United Kingdom

Shanghai, China

Beijing, China

Taipei, Taiwan

Tokyo, Japan

Seoul, Korea

Bangalore, India

Paris, France

Eschborn, Germany

Brussels, Belgium

Etten-Leur, Netherlands

Sollentuna, Sweden

Milano, Italy

Barcelona, Spain

Melbourne, Australia

Mexico City, Mexico

# DISCOVER A NEW STANDARD IN THERMAL ANALYSIS TECHNOLOGY



|                                 |    |
|---------------------------------|----|
| The Discovery DSC               | 2  |
| Innovations                     | 4  |
| Automation                      | 8  |
| Performance                     | 10 |
| Applications                    | 12 |
| Specifications                  | 16 |
| The Discovery TGA               | 18 |
| Innovations                     | 20 |
| Automation                      | 22 |
| Performance                     | 24 |
| Applications                    | 26 |
| Specifications                  | 28 |
| Discovery Series User Interface | 30 |

## DISCOVER A NEW DESIGN

The Discovery DSC represents the latest innovation from TA Instruments. Building on the Tzero® technology first pioneered in our Q Series™ instruments, the Discovery DSC introduces our innovative Diffusion-Bonded Sensor technology. This technology represents the future of temperature and heat flow measurements. The Discovery DSC provides unmatched precision, accuracy, industry-leading sensitivity and resolution.

The result is a Differential Scanning Calorimeter which improves every aspect of DSC performance...

### The New Discovery DSC



# DISCOVER THE DIFFUSION-BONDED SENSOR; THE FUTURE OF TEMPERATURE AND HEAT FLOW MEASUREMENTS



## TECHNOLOGY

Diffusion bonding of metals is accomplished by placing two metal surfaces in contact at an elevated temperature and pressure. Over time, diffusion of the metals occurs at the atomic level, producing an intimate, continuous, high-quality bond. In the Discovery DSC, chromel and constantan are diffusion-bonded to produce **the perfect thermocouple**. In the resultant transducer structure, the diffusion bond is positioned just below the sample surface, **in the perfect position**. The measurement is less sensitive to pan placement effects thereby maximizing repeatability. Unlike alternative designs which employ discreet sensor points, the Diffusion-Bonded Sensor\* represents a continuous thermosensitive surface, dramatically improving sensitivity of the temperature measurement while maintaining a very short time constant for excellent signal resolution.

\*US Patent No. 7,470,057

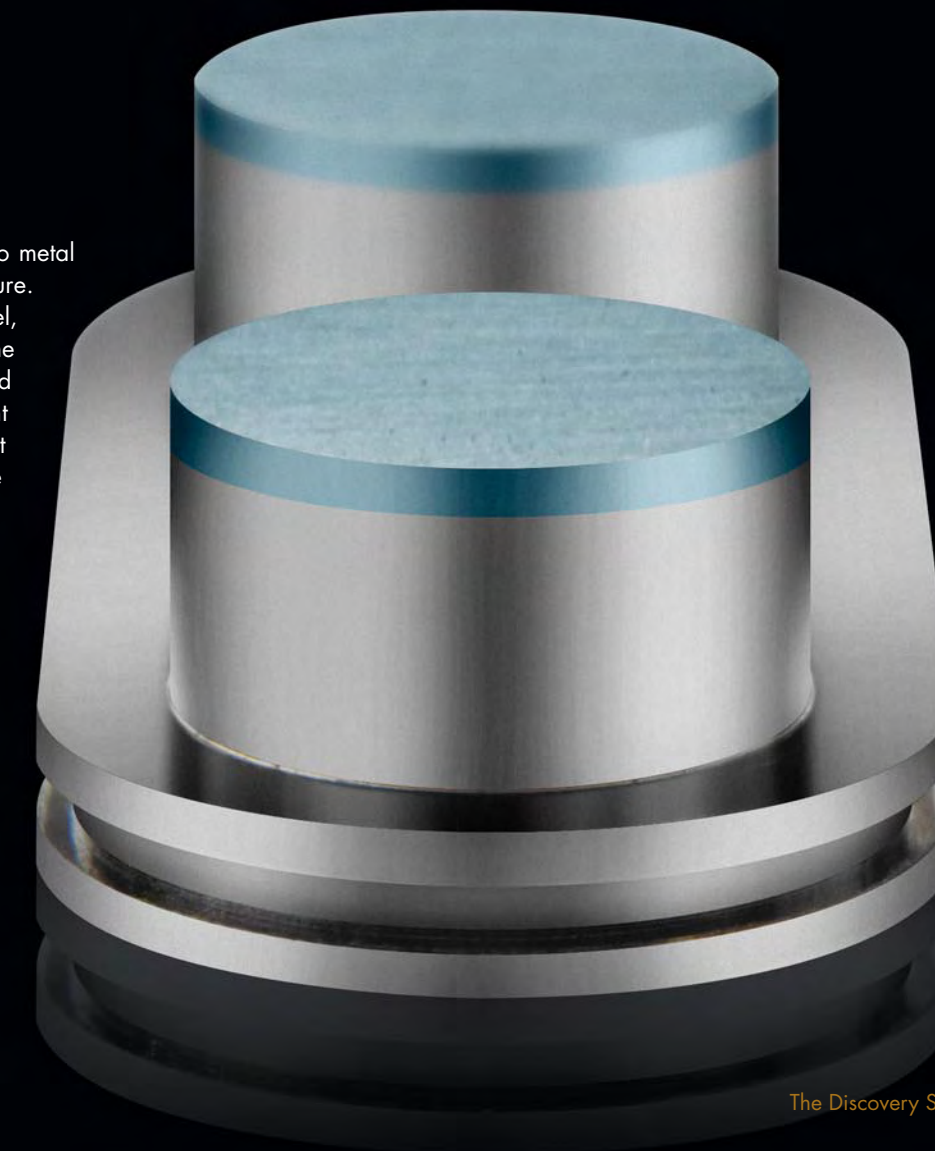

# THE DISCOVERY DSC INCLUDES MULTIPLE INNOVATIONS DESIGNED TO INCREASE PERFORMANCE AND STABILITY

## Uniblock Silver Furnace

The Uniblock furnace is precisely machined from a single block of silver, providing temperature uniformity and ensuring thermal homogeneity. The result is reduced thermal gradients, increased ruggedness and improved measurement precision.



## Temperature Controlled Electronics

The Discovery DSC cell processes the measured signals through an insulated conduit to state-of-the-art temperature-controlled electronics, eliminating the adverse influence of temperature variation on the electronics which is commonly found in competitive technology.



## Diffusion-Bonded Sensor

The heart of the Discovery DSC technology is the Diffusion-Bonded Sensor. To ensure highly-repeatable and stable measurements, the transducer is precision-mounted on a fixed pedestal. Unlike competitive designs where sensors are allowed to move, this pedestal mounting results in a stable configuration with a well-defined heat-flow path unaffected by thermal gradients. The result is unmatched precision and repeatability of the heat flow and temperature measurements.



## Gas-Delivery Module

Our innovative Gas-Delivery Module is standard on the Discovery DSC. The manifold design eliminates tubing and hardware connections which are prone to leaks, ensuring a highly consistent, repeatable inert atmosphere. For experiments which require dynamic or reactive atmospheres, software-controlled gas switching is also supported.

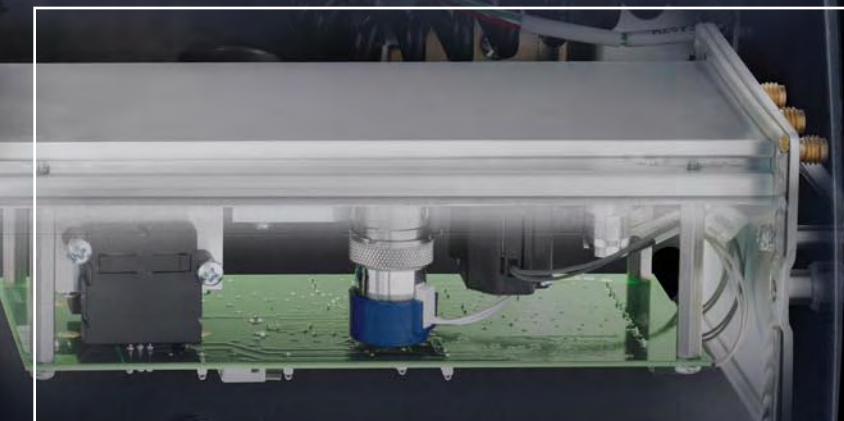

## Reliable Automation

TA's proprietary autosampler technology\* is a standard feature on every Discovery DSC. Field-proven in thousands of laboratories, the reliable and easy-to-use autosampler enables customers to generate superior DSC data around the clock. Powerful new TRIOS software makes it easier than ever for users to manage the sample queue. The re-designed Discovery DSC auto-lid provides consistent and repeatable cell closure, providing effective thermal isolation for the sensor, and further improving measurement repeatability.

\*U.S. Patent No. 6,644,136; 6,652,015;  
6,760,679; 6,823,278

DISCOVER RELIABLE AUTOMATION  
AND ENHANCED PRODUCTIVITY

**Performance** TA Instruments invented Tzero® Technology, a fundamentally better way to measure heat flow. Tzero Technology provides the flattest baselines, and highest combined sensitivity and resolution of any DSC available. The Discovery DSC builds on this innovation, and through our latest advancements provides unmatched precision, repeatability and accuracy of heat flow and temperature measurements, while maintaining our industry-leading sensitivity and resolution. The result is a DSC which improves every aspect of DSC performance, and **delivers meaningful and measurable benefits** to the user.



## Baseline

The foundation of any analytical measurement is the baseline. A well-designed instrument should contribute very little to the sample measurement, and the baseline is the fundamental measurement of this contribution. For a DSC baseline, the right answer is "zero," as any errors in the baseline will propagate directly to the sample data.

The Discovery DSC technology produces a baseline which is perfectly flat, extremely reproducible, and quantitatively correct. This allows for an unmatched degree of accuracy for subsequent enthalpy and heat capacity measurements on your samples.

The figure below demonstrates the performance of the Discovery DSC baseline, in linearity, repeatability and accuracy; critical parameters for quantitative DSC results.

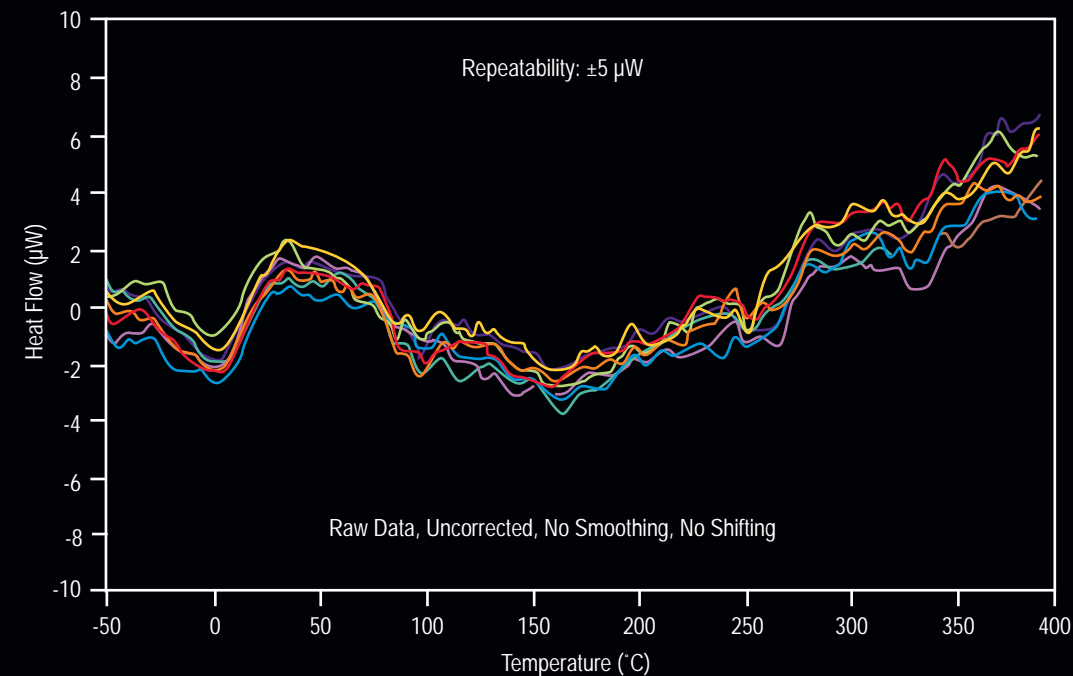



# APPLICATIONS

## Sensitivity & Resolution

There are countless ways to measure the sensitivity of a DSC, and test methods are often exploited to promote performance under a specific set of conditions. However, experienced thermal analysts know that the best DSC provides sensitivity under all experimental conditions. The Discovery DSC delivers the highest sensitivity for a diverse range of heat flow transitions, across a wide range of experimental scanning rates. This is accomplished through the combination of transducer innovations and our patented Tzero® technology which flattens the baseline, maximizes the signal response and minimizes short-term noise. The result is the highest level of sensitivity for your materials, under any experimental condition.

The figures below demonstrate the high level of sensitivity inherent in the Discovery DSC, for both subtle peaks (17 µg sample of indium) and step change transitions such as the 4 µW Tg of a polystyrene sample

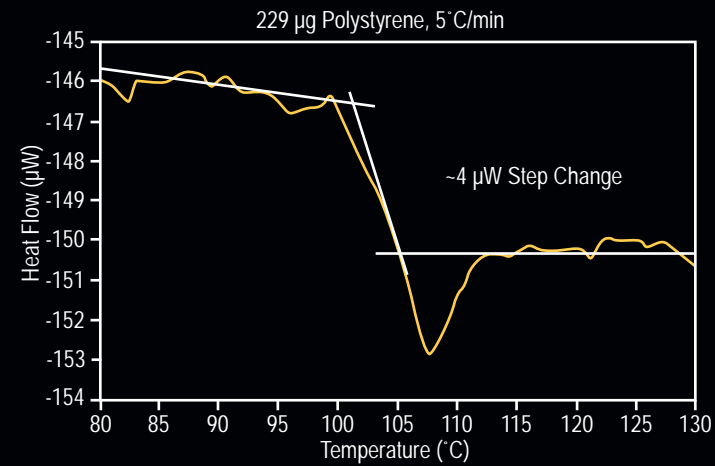
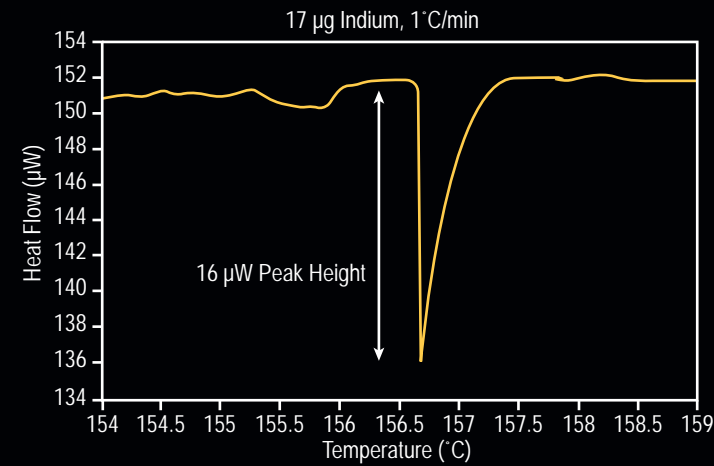

## Resolution

Historically, it was challenging to simultaneously optimize both the sensitivity and resolution of a DSC signal. The faster rates required for higher sensitivity degraded the resolution of the measurement. This limitation is evident in competitive technology, where users are required to choose between a sensor which optimizes sensitivity versus one which provides higher resolution.

The Discovery DSC is designed to simultaneously optimize both sensitivity and resolution. The Diffusion-Bonded transducer optimizes signal quality and sensitivity while minimizing thermal resistance, reducing the time constant of the measurement. The result is the highest combined sensitivity and resolution available in a DSC today.

The figure on the left below shows the resolution performance of the Discovery DSC, when quantified using the industry-standard Indium Response Ratio (H/W). The figure on the right demonstrates a practical application of this high resolution, the analysis of an organic compound at 5°C/min. This sample undergoes solid-state "lambda" transition followed closely by a melt. The superior performance of the Discovery DSC allows for these two transitions to be easily resolved.

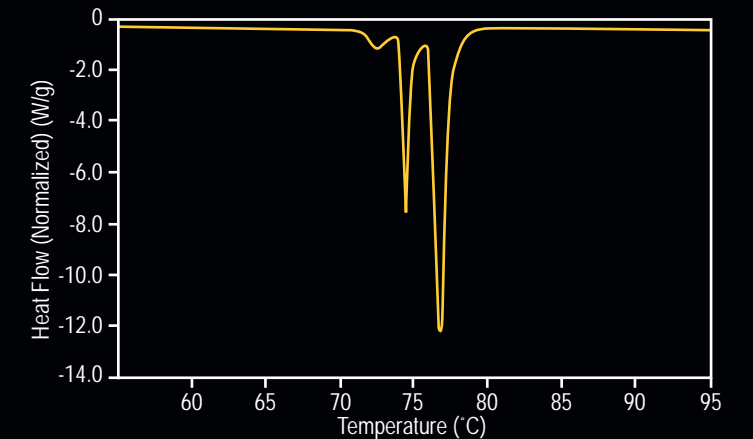
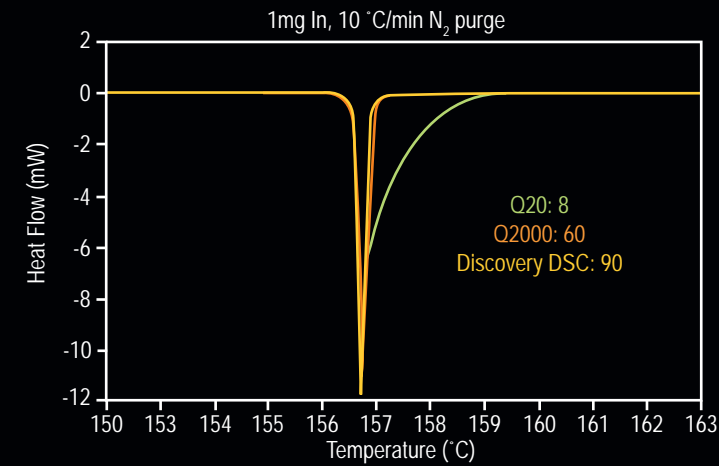

# DISCOVER EFFORTLESS REPEATABILITY IN HEAT FLOW MEASUREMENTS

## APPLICATIONS

### Direct Measurement of Heat Capacity

Many applications require not only the measurement of accurate heat flow, but also quantitative heat capacity. Heat capacity is the fundamental intrinsic property of a material which gives rise to heat exchange, and is an incredibly sensitive indicator of structural morphology in a sample. Historically, heat capacity measurements were performed using a three-run or step-iso method. In addition to the sample measurement, additional runs were necessary to account for baseline artifacts and non-linearity. Whereas these methods can provide accurate heat capacity, they are laborious and time-consuming.

The Discovery DSC is free from the baseline artifacts which affect competitive instruments. This quantitatively-accurate baseline provides for the direct measurement of heat capacity in a single run, without the complications and uncertainty of extraneous events or time-consuming requirements of alternative techniques. This allows for additional information to be gathered about your sample, in an accurate, repeatable and easy-to-use manner. Figure A illustrates the high level of precision and accuracy in direct Cp measurements on the Discovery DSC.

### Precision and Accuracy

An instrument's performance is only as good as its repeatability, and scientists demand results with a high level of precision and accuracy. TA Instruments recognizes this need for precise data and have engineered into the Discovery DSC patented and proprietary technology which provides effortless measurement repeatability. The combination of the technical innovations results in a level of measurement precision previously unattainable.

Figures B-D demonstrate this level of measurement repeatability on both standard materials as well as real-life samples. In all cases, the sample was removed and replaced in between each run.

Figure A

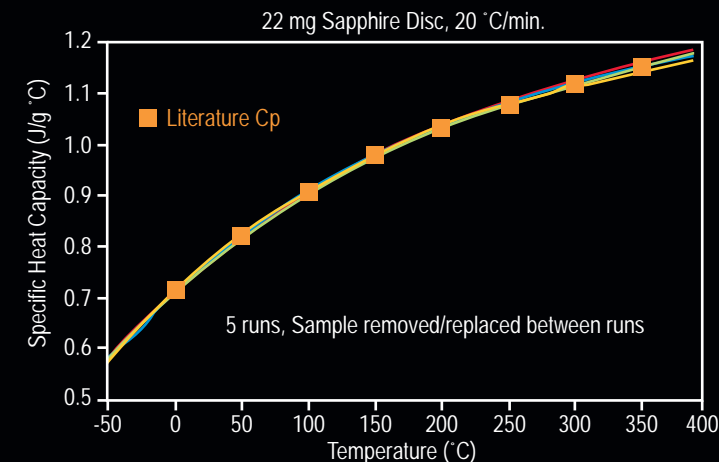

Figure C

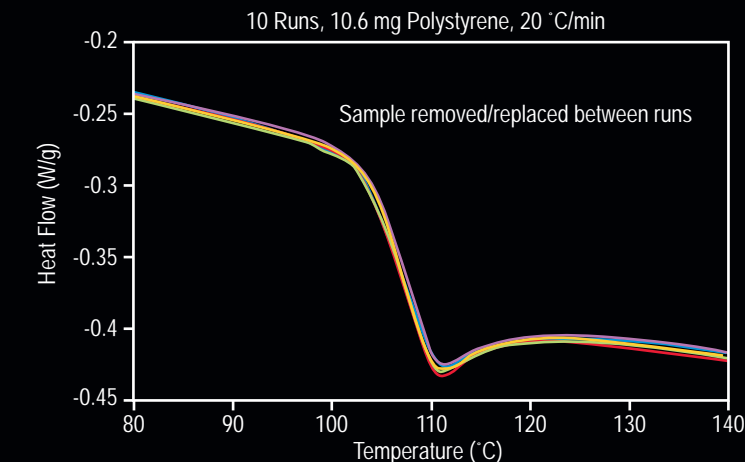

Figure B

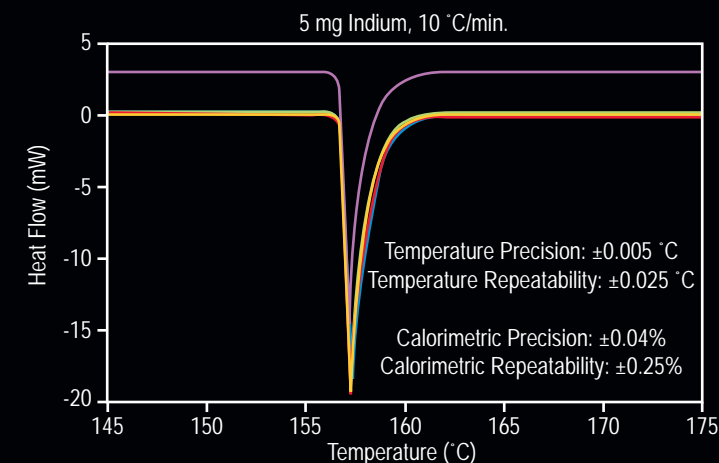
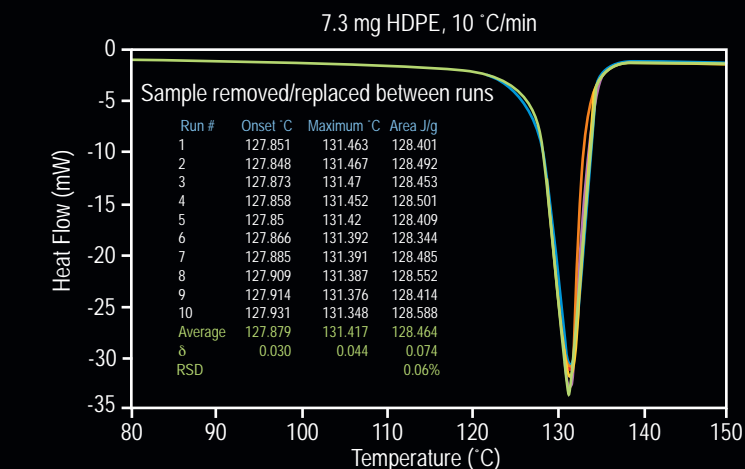

Figure D



## Technical Specifications

| Specification                           | Value         |
|---|---------------|
| Temperature Range                       | -180 – 725 °C |
| Temperature Accuracy                    | ±0.025 °C     |
| Temperature Precision                   | ±0.005 °C     |
| Enthalpy Precision                      | ±0.04%        |
| Heat Flow Noise (rms)                   | ≤0.08 µW      |
| Baseline Linearity (-50° – 400 °C)      | ≤5 µW         |
| Baseline Accuracy (-50° – 400 °C)       | ±20 µW        |
| Baseline Repeatability (-50° – 400 °C)  | ±5 µW         |
| Measurement Time Constant               | ≤0.8s         |
| Indium Response Ratio                   | ≥90           |
| Direct Cp Accuracy (-50° – 400 °C)      | ≤3%           |
| Direct Cp Precision (-50° – 400 °C)     | ≤1%           |
| Direct Cp Repeatability (-50° – 400 °C) | ≤1%           |

## Instrument Features

| Technologies  |           |
|---|-----------|
| Color Touchscreen User Interface                                  | Included  |
| Advanced Tzero® Technology  | Included  |
| Advanced Modulated DSC®   | Included  |
| Direct Cp Measurement   | Included  |
| User Replaceable Cell   | Included  |
| 50-Position Autosampler   | Included  |
| Autolid   | Included  |
| Dual Input Gas Delivery Module                                    | Included  |
| Full Range of Cooling Accessories (RCS90, RCS40, LN2P, FACS, QCA) | Available |
| Photocalorimeter  | Available |
| Optical Accessory Kit (Raman, NIR)                                | Available |
| Compatible with Q Series™ RCS Systems (RCS90 & RCS40)             |           |
| Compatible with Tzero® DSC Sample Encapsulation Press             |           |

## DISCOVER POWERFUL THERMOGRAVIMETRIC TECHNOLOGY

The Discovery TGA features our industry-leading thermobalance, innovative IR-heated furnace, patented\* Hi-Res TGA™, and an autosampler unmatched in flexibility and reliability. The new Gas Delivery Module provides gas switching, and blending capabilities for the ultimate in atmospheric control. The Discovery User Interface simplifies interaction with the instrument, and provides for effortless control and monitoring of TGA experiments. The result is the ultimate in sensitivity, accuracy, resolution and temperature control...

### The New Discovery TGA

\*U.S. Patent No. 5,165,792 Canadian Patent No. 2,051,578 European Patent No. 0494492



## THE DISCOVERY TGA INCLUDES MULTIPLE INNOVATIONS DESIGNED TO INCREASE PERFORMANCE

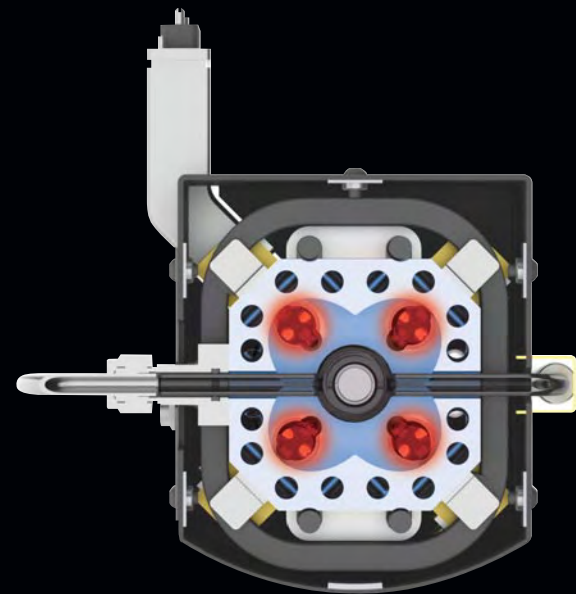

### IR Furnace

Our unique furnace technology employs infrared heating providing the widest range of temperature and heating rates available. This patented design utilizes four symmetrically-placed halogen lamps with gold elliptical reflectors surrounding a SiC sample enclosure. IR radiation from the halogen lamps result in radiative heating of the SiC. Active water-cooling of the surrounding furnace body provides an efficient heat-sink and facilitates precise temperature and rate control. The Discovery TGA can be heated from 0.1 to 500°C/min in linear control, or over 2000°C/min in ballistic heating over the range ambient to 1200°C.

The Discovery TGA furnace includes an integrated electromagnet for automated calibration with Curie point standards. An optional heated outlet is available for evolved gas analysis techniques such as TGA-FTIR and TGA-MS.

### Gas Delivery Module

The Gas-Delivery Module (GDM) is standard on the Discovery TGA. The manifold design eliminates tubing and hardware connections which are prone to leaks, ensuring a highly consistent, repeatable atmosphere. For experiments which require dynamic or reactive atmospheres, software-controlled gas switching and blending is supported (2 gas or 4 gas). Gas flow rates are automatically controlled and recorded to ensure confidence in the quality and repeatability of experimental results.

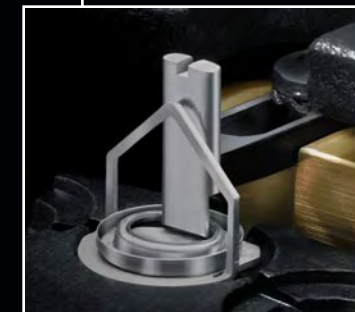
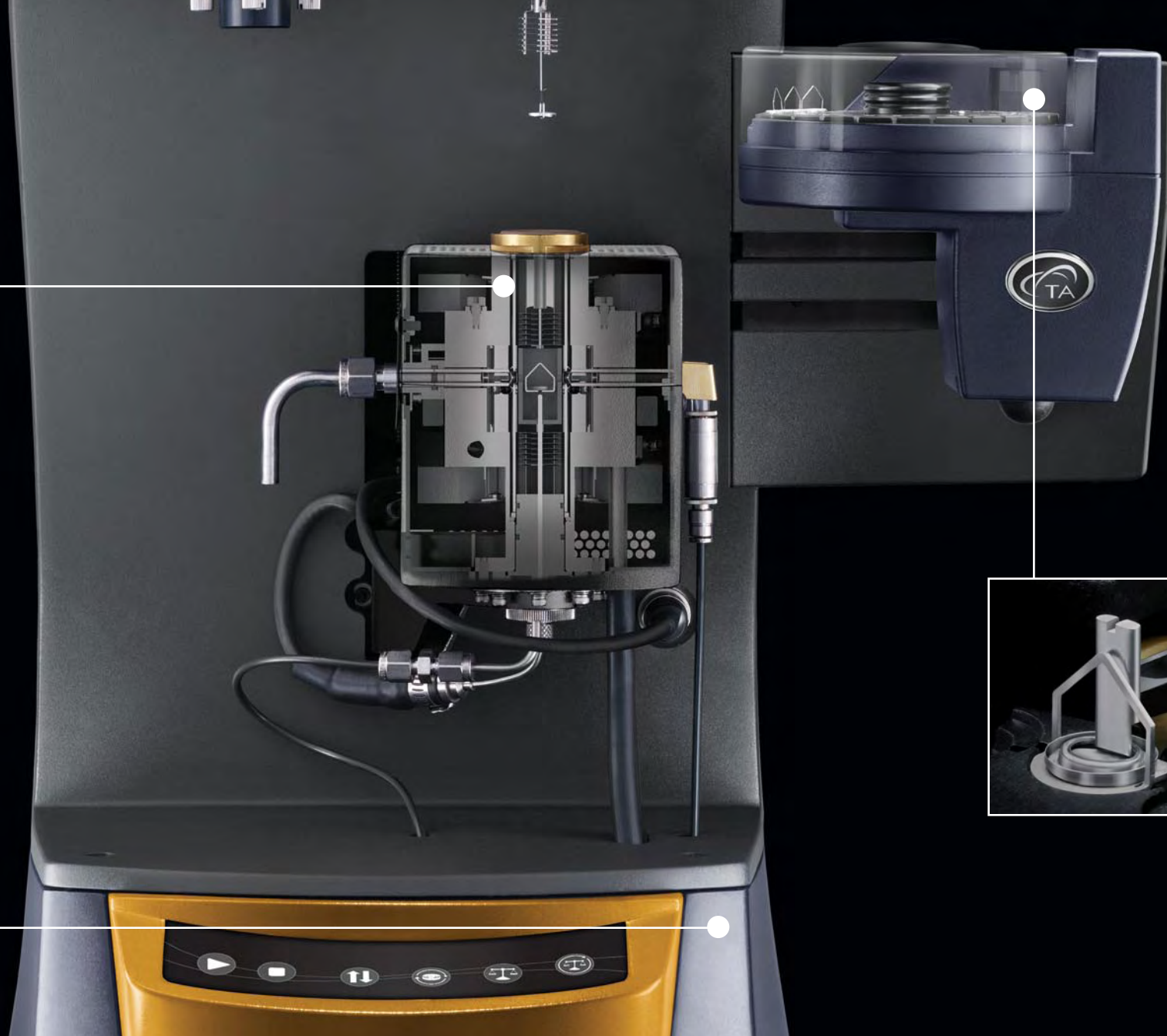
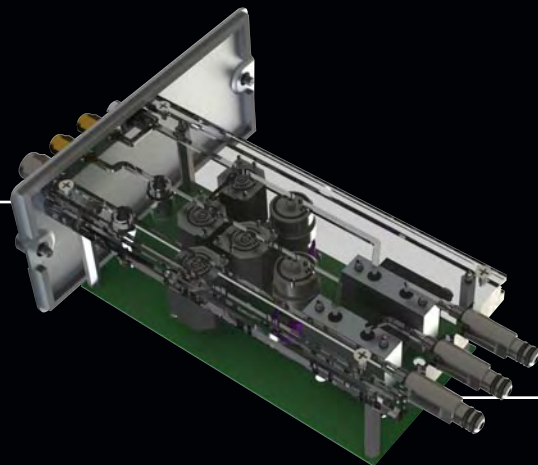

### Pan-punching

A special auto-sampler feature is the patented pan-punching mechanism designed to reliably open sealed aluminum pans used to protect atmosphere sensitive samples.

## Balance

The heart of the Discovery TGA is our proprietary thermobalance. At TA Instruments, we understand the importance of making accurate gravimetric measurements under every experimental condition. As such, our vertical null-balance and integrated electronics are precisely temperature-controlled and effectively isolated from the furnace, resulting in stability and accuracy of the measured weight which is unmatched by any competitive technology.

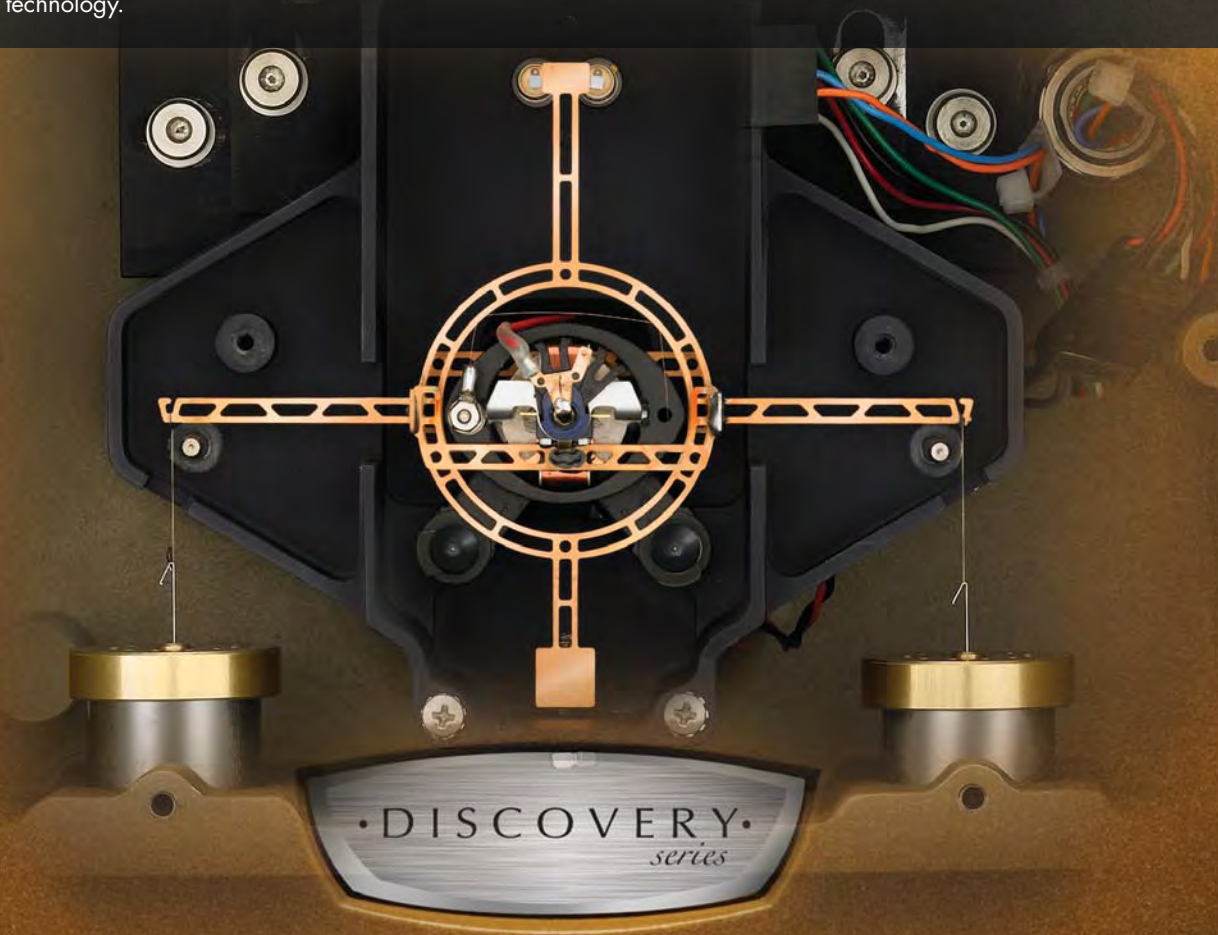

## Autosampler

The Discovery TGA features our reliable 25-position autosampler. Offering the ultimate in flexibility, the autosampler supports multiple pan types and includes our patented pan-punching mechanism to open sealed aluminum pans just prior to analysis. This allows for effective isolation of air-sensitive or volatile samples while maintaining the productivity of the autosampler.

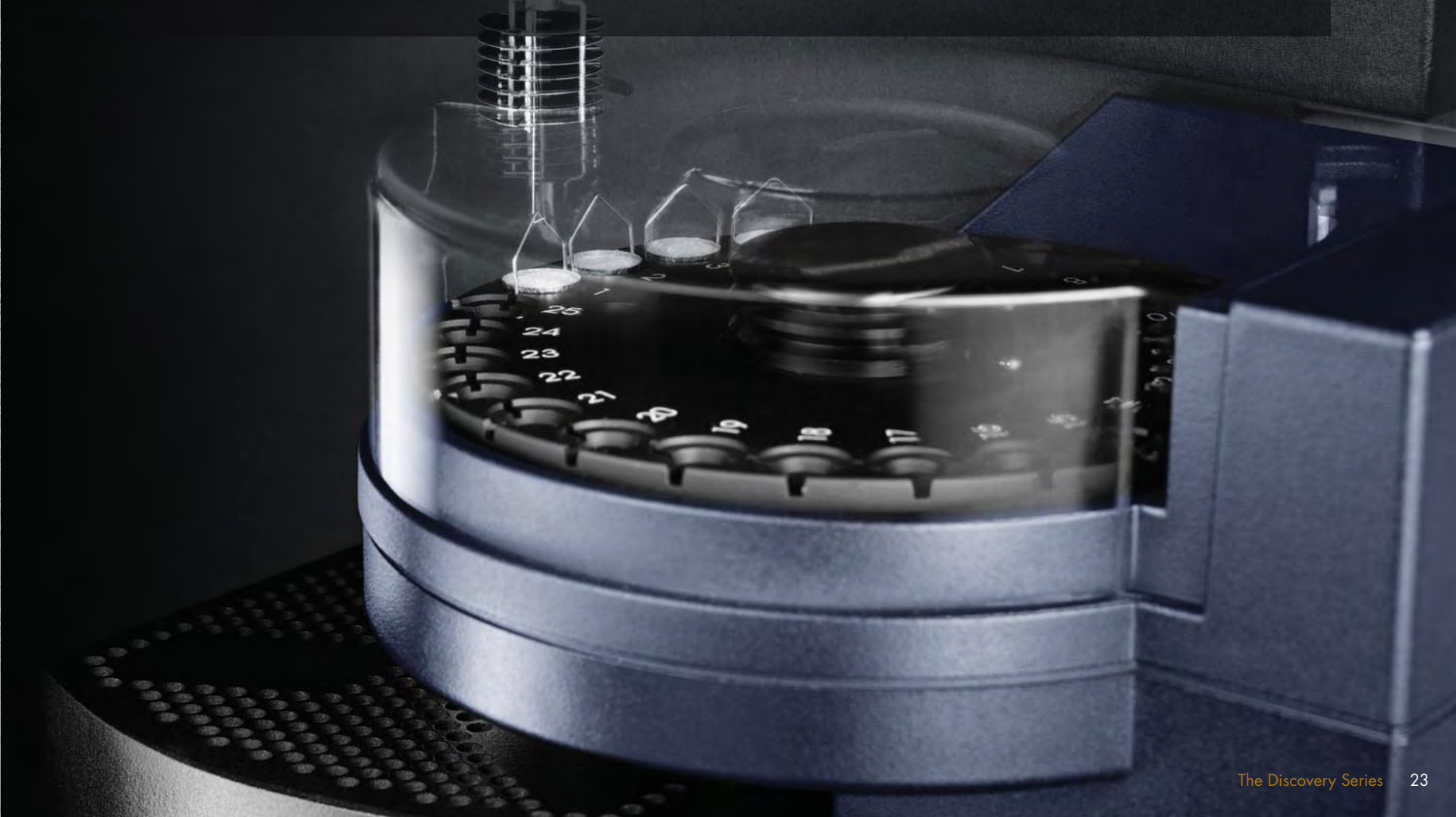

# PERFORMANCE

Thermogravimetric performance depends on two fundamental variables: weight measurement and temperature control. The Discovery TGA is designed to optimize both of these through innovative design and precise construction.

## Weight Measurement

An analytical balance is designed to provide accurate measurement of weight, usually at ambient temperature. A thermobalance extends this measurement, and provides the weight measurement under dynamic conditions of temperature and atmosphere. A good thermobalance should be able to provide accuracy under all achievable instrumental conditions, and the TGA baseline is the fundamental measurement of this accuracy. After taring, the theoretical value for the baseline is zero, and this value should be obtained at every temperature, under all conditions.

Some competitive technologies employ good balances, but their performance begins to falter once the furnace is activated. Complicating effects of magnetic fields, buoyancy and inferior design can cause instrumental artifacts such as offset, drift and noise which can compromise accurate TGA performance. The only solution for these effects is to constantly perform baseline or background subtractions, which reduces lab productivity and can potentially introduce new sources of error into the resultant measurement.

The Discovery TGA incorporates unique and proprietary technology to provide the most accurate measurement of weight under all experimental conditions. This performance can be quantified by examination of the Discovery TGA baseline, as shown in the Figure to the right. The theoretical value for the baseline is zero at all conditions; any deviation from this value represents systematic error. The Discovery TGA delivers a flat, fundamentally accurate baseline free from complicating artifacts such as curvature and slope often seen in competitive technology. Baseline subtractions are never required. This performance is also highly repeatable.

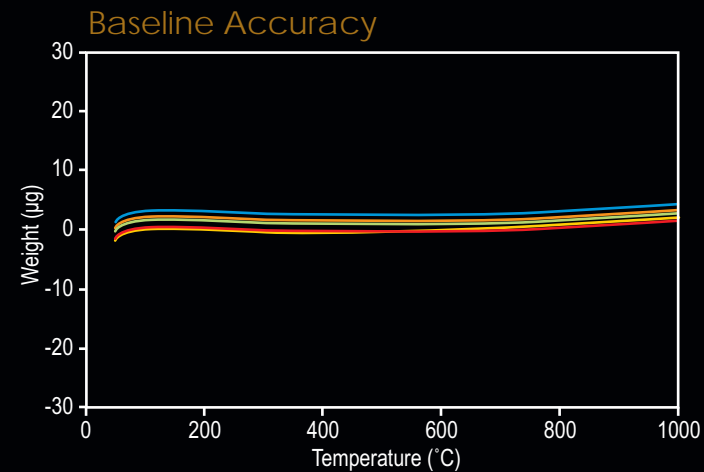

## Temperature Control

Thermogravimetric experiments require precise, repeatable temperature control. The Discovery TGA features our proprietary IR-heated furnace which delivers unmatched control and stability in ballistic, controlled-heating, and isothermal experiments. The figure on the left illustrates the rapid response and equilibration of the Discovery TGA. The commanded 1000°C temperature jump is precisely achieved in less than 60 seconds, peaking at a ballistic rate of over 2000°C/min.

Isothermal control of temperature is critical for weight measurement stability. The figure on the right shows the temperature and corresponding weight signals for an isothermal baseline measured over 12 hours. The temperature deviates less than 0.005°C, which contributes to weight stability within 0.5 µg over the duration of the experiment.

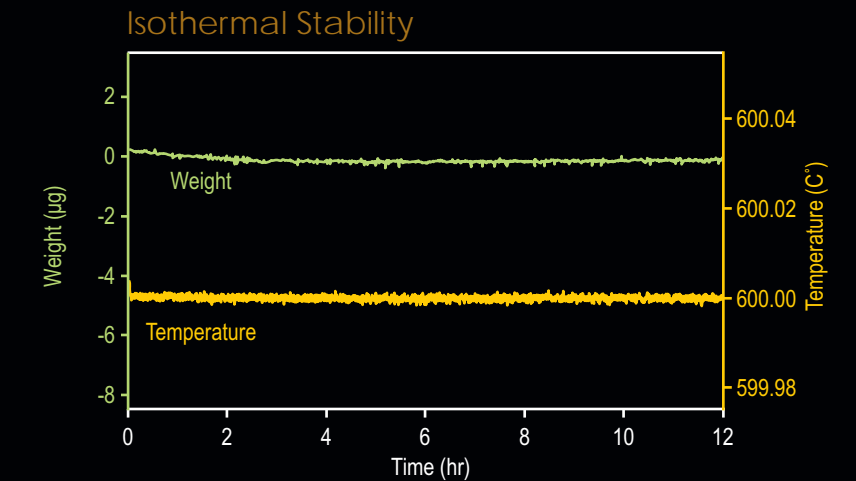
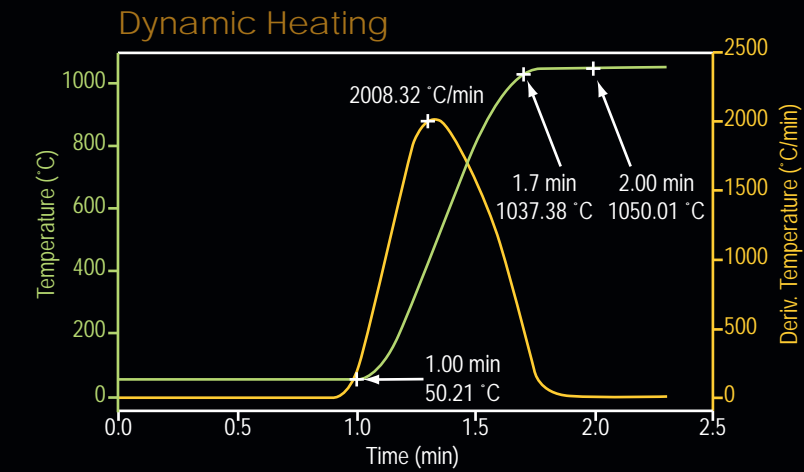

# APPLICATIONS

## Wide Heating Rate Range Improves Productivity

The IR-Furnace of the Discovery TGA is able to control over a wide range of linear rates, while maintaining quantitative accuracy in weight loss. The data in this figure show the analysis of the two-step decomposition of a polymer sample analyzed at three different heating rates. Even at the fastest rate of 500°C/min, the quantitative weight loss measurement is consistent. This allows for a 10X increase in productivity by running samples at elevated rates without any loss of accuracy.

## High Sensitivity for Small Weight Loss

The baseline stability of the Discovery TGA allows for the ultimate in high-sensitivity measurements. The data in this figure shows the analysis of the decomposition of a 5.4 mg sample of high-density polyethylene (HDPE) doped with 10 µg of PVC. The inset view shows an expanded scale, where the first step of the PVC decomposition is clearly detected and quantified, even though the corresponding weight change is less than 6 micrograms!

## High Resolution™ TGA

This figure compares the decomposition profile plots of a polyurethane material by standard and by Hi-Res™ TGA. The superior resolution provided by the Hi-Res™ technique is clearly evident in both the TGA and first derivative (DTG) signals. The latter signal is especially useful in defining the onset and end set of the individual weight loss segments, as well as indicating subtle events that provide a “fingerprint” of the sample.

## Modulated TGA™

The figure to the right shows data from an MTGA™ kinetic study of the effect of temperature on the decomposition of 60 % ethylene vinyl acetate (EVA) in a single analysis. The plot quantitatively shows the EVA decomposition profile and changes in activation energy as functions of temperature. The data supports a dual-step decomposition mechanism. MTGA can also monitor activation energy as a function of conversion, which indicates the mechanism involved.

Wide Heating Rate Range Improves Productivity

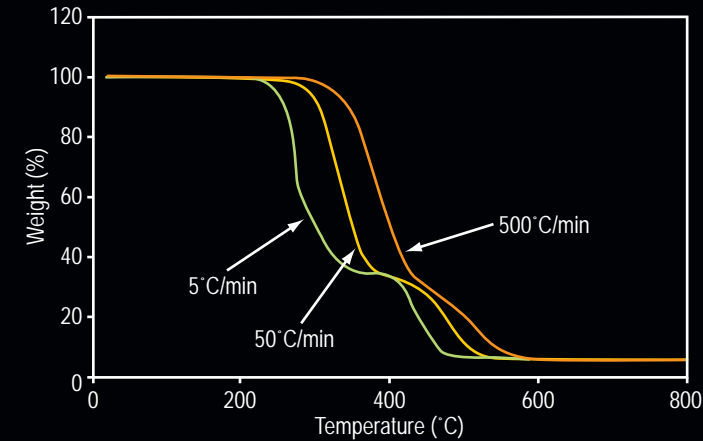

High Sensitivity for Small Weight Loss

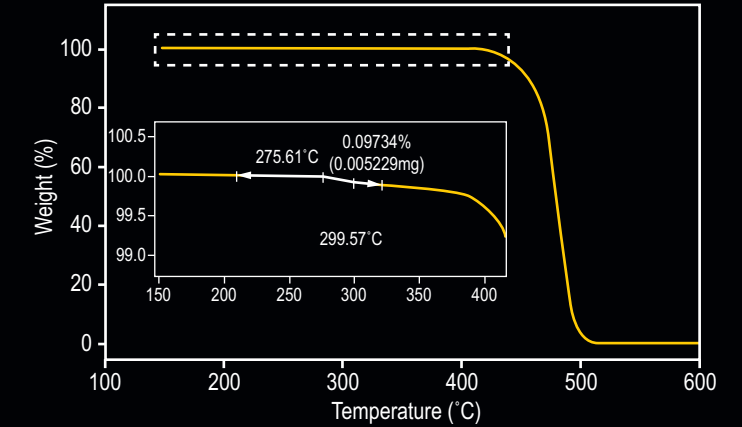

High Resolution™ TGA

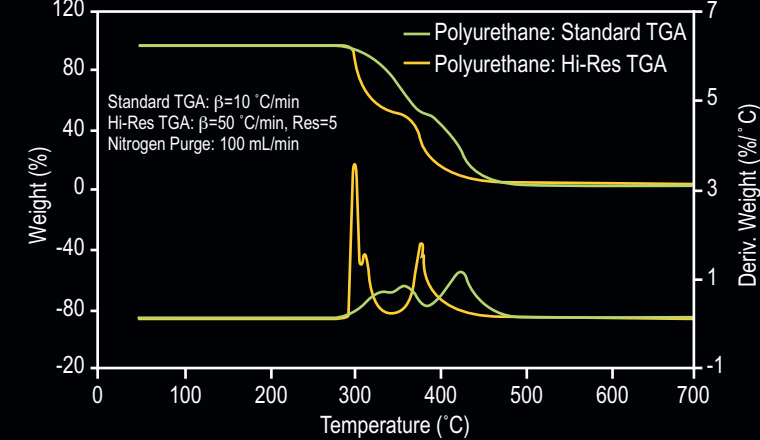

Modulated TGA™

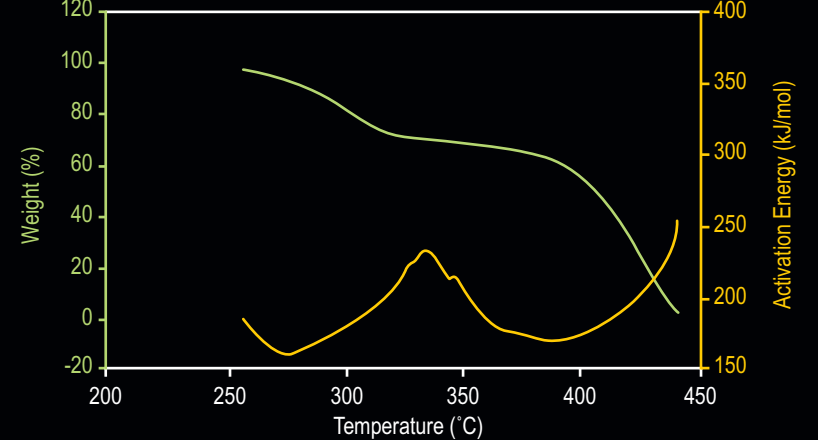



## Technical Specifications

| Specification  | Value   |
|--|---|
| Temperature Range  | Ambient - 1200 °C                                     |
| Isothermal Temperature Accuracy  | ±1 °C   |
| Temperature Precision  | ±1 °C   |
| Heating Rate Range   | 0.1 – 500 °C/min (linear)<br>>2000 °C/min (ballistic) |
| Furnace Cooling (Forced air/N <sub>2</sub> )   | 1200 to 35 °C in <10 min.                             |
| Sample Weight Capacity   | 750 mg  |
| Dynamic Weighing Range   | ±100mg  |
| Weighing Accuracy  | ±0.1%   |
| Weighing Precision   | ±0.01%  |
| Sensitivity  | <0.1 µg   |
| Short-term Noise (rms)   | <0.03 µg  |
| Baseline Linearity (50-1000°C)   | <1 µg   |
| Baseline Drift<br>(50-1000°C, 20°C/min, N <sub>2</sub> purge, no baseline subtraction) | <10 µg  |
| Signal Resolution  | 0.001 µg  |

## Instrument Features

| Technologies                     |                        |
|----------------------------------|------------------------|
| Color Touchscreen User Interface | Included               |
| Hi-Res TGA™                      | Included               |
| Modulated TGA™                   | Included               |
| Auto-Stepwise TGA                | Included               |
| 25-Position Autosampler          | Included               |
| Integrated Electromagnet         | Included               |
| Heated EGA Furnace Adapter       | Available              |
| Dual Input Gas Delivery Module   | Included               |
| 4-Gas Input Gas Delivery Module  | Available              |
| Vacuum Operation                 | >10 <sup>-2</sup> torr |
| TGA/MS Operation                 | Available              |
| TGA/FTIR Operation               | Available              |



DISCOVER A  
REVOLUTIONARY  
NEW USER INTERFACE



## User Interface

The Discovery Series redefines the interaction with the instrument. The large, intuitive display and interactive menus guide the user to perform calibrations, control autosampler routines, and load or unload samples. Simple experiments can be programmed and initiated through the new QuickRun menu, and experimental progress can be monitored with the customizable real-time signal display.



[tainstruments.com](http://tainstruments.com)